

GUTTERCREST

ALUMINIUM

BOX GUTTERS

SMALL SIZES

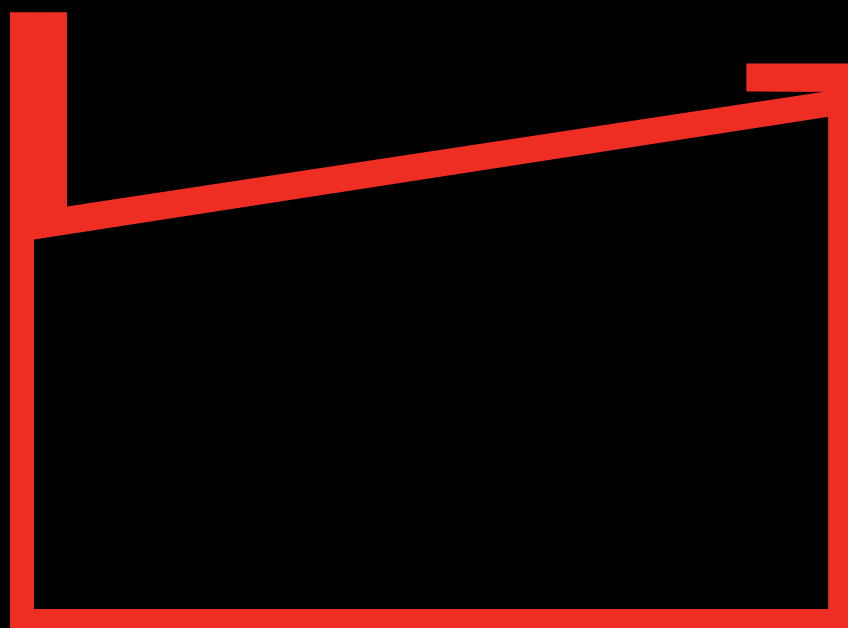

PRICE LIST

PRICE LIST

BOX GUTTER SYSTEM - SMALL SIZES

STANDARD GUTTER LENGTHS

Gutter (mm)	100 x 75	100 x 100	125 x 100	150 x 100
3.0mtr	BX1/1	BX2/1	BX3/1	BX4/1
MILL	66.39	76.60	78.95	80.17
PPC	73.47	85.00	88.11	89.99
1.8mtr	BX1/2	BX2/2	BX3/2	BX4/2
MILL	42.00	46.92	53.21	53.97
PPC	45.54	51.12	57.80	58.89

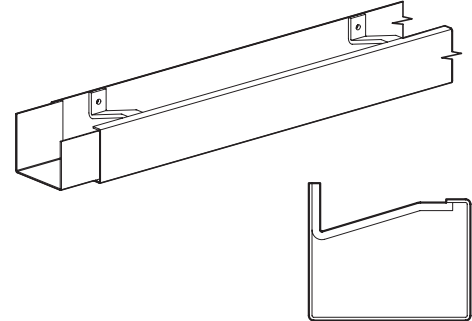

ANGLES INTERNAL & EXTERNAL

Gutter (mm)	100 x 75	100 x 100	125 x 100	150 x 100
90° External	BX1/3	BX2/3	BX3/3	BX4/3
MILL	35.02	37.75	40.00	43.19
PPC	36.29	39.25	41.82	45.23
90° Internal	BX1/4	BX2/4	BX3/4	BX4/4
MILL	35.02	37.75	40.00	43.19
PPC	36.29	39.25	41.82	45.23
135° External	BX1/5	BX2/5	BX3/5	BX4/5
MILL	33.73	35.98	39.89	40.81
PPC	34.86	37.31	41.51	42.62
135° Internal	BX1/6	BX2/6	BX3/6	BX4/6
MILL	33.73	35.98	39.89	40.81
PPC	34.86	37.31	41.51	42.62
Irregular External	BX1/7	BX2/7	BX3/7	BX4/7
MILL	62.62	66.93	71.47	79.09
PPC	64.33	68.95	73.77	81.71
Irregular Internal	BX1/8	BX2/8	BX3/8	BX4/8
MILL	62.62	66.94	71.47	79.09
PPC	64.33	68.96	73.77	81.71

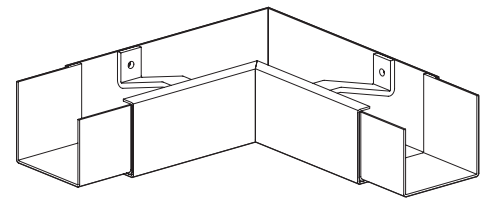

Internal Angle

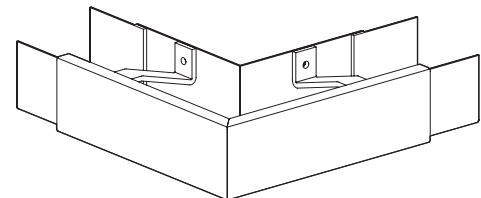

External Angle

STOP ENDS

Gutter (mm)	100 x 75	100 x 100	125 x 100	150 x 100
Stop End Right Hand	BX1/10	BX2/10	BX3/10	BX4/10
MILL	5.19	5.38	5.54	5.63
PPC	5.69	5.88	6.04	6.13
Stop End Left Hand	BX1/11	BX2/11	BX3/11	BX4/11
MILL	5.19	5.38	5.54	5.63
PPC	5.69	5.88	6.04	6.13

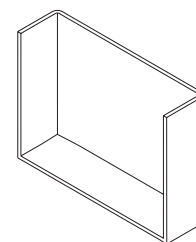

Right Hand Shown

Please Note: These are Internal Stop Ends

PRICE LIST

BOX GUTTER SYSTEM - SMALL SIZES

SLEEVE OUTLETS - ROUND

Gutter (mm)	100 x 75	100 x 100	125 x 100	150 x 100
63mm Ø	BX1/SO13	BX2/SO13	BX3/SO13	BX4/SO13
MILL	6.70	6.70	6.70	6.70
PPC	7.20	7.20	7.20	7.20
75mm Ø	BX1/SO14	BX2/SO14	BX3/SO14	BX4/SO14
MILL	6.70	6.70	6.70	6.70
PPC	7.20	7.20	7.20	7.20
100mm Ø	BX1/SO15	BX2/SO15	BX3/SO15	BX4/SO15
MILL	-	-	8.00	8.00
PPC	-	-	8.50	8.50
125mm Ø	BX1/SO16	BX2/SO16	BX3/SO16	BX4/SO16
MILL	-	-	-	8.00
PPC	-	-	-	8.50
150mm Ø	BX1/SO17	BX2/SO17	BX3/SO17	BX4/SO17
MILL	-	-	-	-
PPC	-	-	-	-

Please Note

Sleeve Outlets can be used in place of Running Outlets giving increased flexibility and cost efficiency.

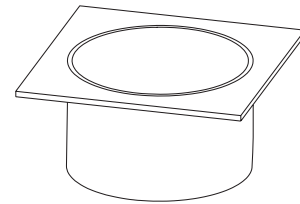

SLEEVE OUTLETS - SQUARE & RECTANGULAR

Gutter (mm)	100 x 75	100 x 100	125 x 100	150 x 100
75 x 50mm	BX1/SO18	BX2/SO18	BX3/SO18	BX4/SO18
MILL	6.70	6.70	6.70	6.70
PPC	7.20	7.20	7.20	7.20
75 x 75mm	BX1/SO19	BX2/SO19	BX3/SO19	BX4/SO19
MILL	6.70	6.70	6.70	6.70
PPC	7.20	7.20	7.20	7.20
100 x 75mm	BX1/SO20	BX2/SO20	BX3/SO20	BX4/SO20
MILL	6.70	6.70	6.70	6.70
PPC	7.20	7.20	7.20	7.20
100 x 100mm	BX1/SO21	BX2/SO21	BX3/SO21	BX4/SO21
MILL	-	-	8.00	8.00
PPC	-	-	8.50	8.50
100 x 150mm	BX1/SO22	BX2/SO22	BX3/SO22	BX4/SO22
MILL	-	-	8.00	8.00
PPC	-	-	8.50	8.50

Please Note

Sleeve Outlets can be used in place of Running Outlets giving increased flexibility and cost efficiency.

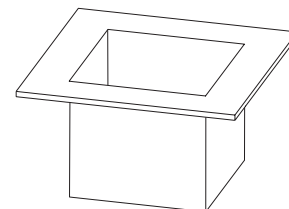

PRICE LIST

BOX GUTTER SYSTEM - SMALL SIZES

RUNNING OUTLETS - ROUND

Gutter (mm)	100 x 75	100 x 100	125 x 100	150 x 100
63mm Ø	BX1/13	BX2/13	BX3/13	BX4/13
MILL	37.82	38.99	40.55	41.80
PPC	38.70	40.03	41.69	43.02
75mm Ø	BX1/14	BX2/14	BX3/14	BX4/14
MILL	37.93	39.11	40.67	42.31
PPC	38.81	40.15	41.81	43.53
100mm Ø	BX1/15	BX2/15	BX3/15	BX4/15
MILL	-	-	40.28	41.92
PPC	-	-	41.42	43.14
125mm Ø	BX1/16	BX2/16	BX3/16	BX4/16
MILL	-	-	-	44.62
PPC	-	-	-	46.00

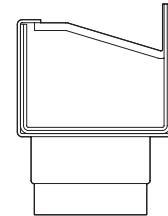
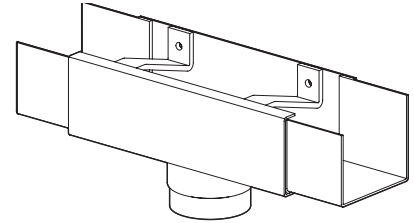

Please Note

Sleeve Outlets can be used in place of Running Outlets giving increased flexibility and cost efficiency.

RUNNING OUTLETS - SQUARE & RECTANGULAR

Gutter (mm)	100 x 75	100 x 100	125 x 100	150 x 100
75 x 50mm	BX1/18	BX2/18	BX3/18	BX4/18
MILL	37.82	38.99	40.53	41.78
PPC	38.73	40.06	41.67	43.00
75 x 75mm	BX1/19	BX2/19	BX3/19	BX4/19
MILL	37.92	39.10	40.64	41.89
PPC	38.83	40.17	41.78	43.11
100 x 75mm	BX1/20	BX2/20	BX3/20	BX4/20
MILL	38.21	39.38	40.90	42.43
PPC	39.12	40.45	42.04	43.65
100 x 100mm	BX1/21	BX2/21	BX3/21	BX4/21
MILL	-	-	41.83	43.36
PPC	-	-	42.97	44.58
150 x 100mm	BX1/22	BX2/22	BX3/22	BX4/22
MILL	-	-	44.25	45.40
PPC	-	-	45.54	46.78

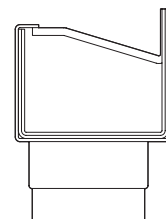
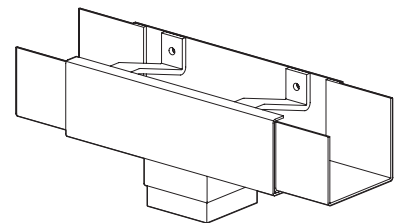

Please Note

Sleeve Outlets can be used in place of Running Outlets giving increased flexibility and cost efficiency.

PRICE LIST

FIXINGS & SEALANTS

Code	Qty	Description	Price
GM1	25	Gutter Fixing 38 x 5.5 A2 Stainless Steel	4.42
GM2	100	Gutter Fixing 38 x 5.5 A2 Stainless Steel	12.00
GM3	200	Gutter Fixing 38 x 5.5 A2 Stainless Steel	22.40



GM1 - GM5

Code	Qty	Description	Price
GM201	25	4.8 x 14.7 All Aluminium sealed Rivet	3.13
GM202	100	4.8 x 14.7 All Aluminium sealed Rivet	12.03
GM203	200	4.8 x 14.7 All Aluminium sealed Rivet	23.94



GM201 - GM203

Code	Qty	Description	Price
GM610	25	6.3mm STRUCTURAL Aluminium Rivet	10.66
GM620	100	6.3mm STRUCTURAL Aluminium Rivet	37.44



GM610 - GM620

Code	Qty	Description	Price
GM20	25	Downpipe Fixing 6 x 50 A2 Stainless Steel	9.05
GM21	100	Downpipe Fixing 6 x 50 A2 Stainless Steel	31.17



GM20 - GM21

Code	Qty	Description	Price
GM30	1	380ml Cartridge Silicone Sealant - Grey	11.07
GM32	1	1no 12mtr Reel Butyl Tape 12mm x 3mm	4.67
GM34	1	1 Litre Sealant Cleaner	10.96
GM40	1	0.5ltr Touch Up Paint - Colour to match order	23.35
GM50	1	1no Drill Bit 4.8mm	2.10
GM51	1	1no Drill Bit 6.4mm	3.32



GM30



GM32



GM50 - GM60

Code	Qty	Description	Price
GM910	1	Standard Rainwater Rivet Gun	19.52
GM920	1	Professional Rivet Gun - Interchangeable collets for rainwater and structural rivets	111.10



GM910



GM920

PRICE LIST

CARRIAGE CHARGES

GUTTERS, DOWNPIPES & HOPPERS

TOTAL NET ORDER VALUE (EXCLUDING VAT)		PRICE
£0 - £99	BOXED UP TO 10KG	£15.00 Min Charge
£0 - £99	3M LENGTHS UP TO 10KGS	£30.00
£100 - £624		£40.00
£625 - £1249		£55.00
£1250 PLUS		FREE DELIVERY

Delivery Exclusions Apply: Please see the Charges section below

COPING, FASCIAS & SOFFITS

TOTAL NET ORDER VALUE (EXCLUDING VAT)	PRICE
£0 - £150	£40.00
£151 - £1249	£95.00
£1250 PLUS	FREE DELIVERY

Delivery Exclusions Apply: Please see the Charges section below

CHARGES

With a fleet of Guttercrest vehicles and outside couriers, we deliver all our aluminium products to your local builders merchant or direct to site.

SCOTTISH MAINLAND

Standard carriage charges apply on Postcode areas: DG, EH, G, KA, KY, TD

ALSO TO INCLUDE: DD1 - DD7, FK1 - FK7, FK9 - FK15, FK8 STERLING ONLY (Rest of FK8 will be price on application), KY1 - KY16, PA1 - PA19, PH1 - PH4, PH12 - PH14

All other Scottish Mainland, carriage price on application.

NON MAINLAND

For delivery to Northern Ireland, The Republic of Ireland and all offshore Islands, carriage Price on application.

EXPORT

Price on application.

Tel: +44 (0)1691 663300

Email: info@guttercrest.co.uk

VAT will be charged at the appropriate rate.

