

GUTTERCREST

ALUMINIUM

**MOULDED OGEE LARGE
GUTTERS**



PRICE LIST

PRICE LIST

MOULDED OGEE GUTTER SYSTEM - LARGE SIZES

STANDARD GUTTER LENGTHS

Gutter (mm)	175 x 125	200 x 150	300 x 200
3.0mtr	MOG4/1	MOG5/1	MOG6/1
MILL	101.99	116.00	158.38
PPC	112.76	128.47	176.11
1.8mtr	MOG4/2	MOG5/2	MOG6/2
MILL	63.24	71.38	99.94
PPC	68.63	77.62	108.81

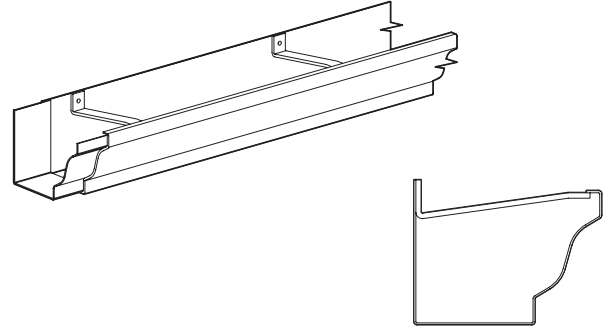

ANGLES - INTERNAL & EXTERNAL

Gutter (mm)	175 x 125	200 x 150	300 x 200
90° External	MOG4/3	MOG5/3	MOG6/3
MILL	49.56	61.91	83.28
PPC	51.70	64.49	87.55
90° Internal	MOG4/4	MOG5/4	MOG6/4
MILL	49.56	61.91	82.93
PPC	51.70	64.49	87.20
135° External	MOG4/5	MOG5/5	MOG6/5
MILL	47.65	58.62	82.31
PPC	49.39	60.72	85.54
135° Internal	MOG4/6	MOG5/6	MOG6/6
MILL	47.65	58.62	82.31
PPC	49.39	60.72	85.54
Irregular External	MOG4/7	MOG5/7	MOG6/7
MILL	85.22	101.11	146.80
PPC	87.18	103.58	151.45
Irregular Internal	MOG4/8	MOG5/8	MOG6/8
MILL	85.22	101.11	146.81
PPC	87.18	103.58	151.46

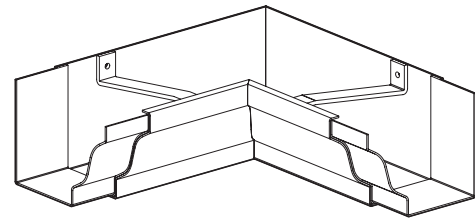

Internal Angle

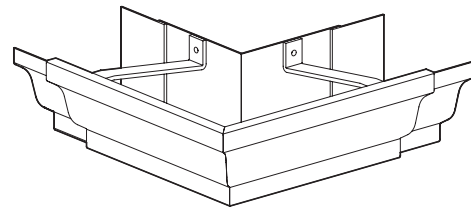

External Angle

STOP ENDS

Gutter (mm)	175 x 125	200 x 150	300 x 200
Stop End Right Hand	MOG4/10	MOG5/10	MOG6/10
MILL	11.86	13.10	17.11
PPC	12.36	13.60	17.68
Stop End Left Hand	MOG4/11	MOG5/11	MOG6/11
MILL	11.86	13.10	17.11
PPC	12.36	13.60	17.68

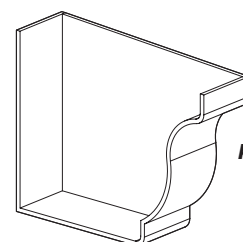

Right Hand shown

Please Note: These are Internal Stop Ends

PRICE LIST

MOULDED OGEE GUTTER SYSTEM - LARGE SIZES

SLEEVE OUTLETS - ROUND

Gutter (mm)	175 x 125	200 x 150	300 x 200
63mm Ø	MOG4/SO13	MOG5/SO13	MOG6/SO13
MILL	6.70	6.70	6.70
PPC	7.20	7.20	7.20
75mm Ø	MOG4/SO14	MOG5/SO14	MOG6/SO14
MILL	6.70	6.70	6.70
PPC	7.20	7.20	7.20
100mm Ø	MOG4/SO15	MOG5/SO15	MOG6/SO15
MILL	8.00	8.00	8.00
PPC	8.50	8.50	8.50
125mm Ø	MOG4/SO16	MOG5/SO16	MOG6/SO16
MILL	-	8.00	8.00
PPC	-	8.50	8.50
150mm Ø	MOG4/SO17	MOG5/SO17	MOG6/SO17
MILL	-	-	11.50
PPC	-	-	12.00

Please Note

Sleeve Outlets can be used in place of Running Outlets giving increased flexibility and cost efficiency.

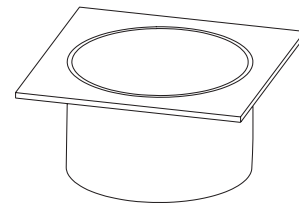

SLEEVE OUTLETS - SQUARE & RECTANGULAR

Gutter (mm)	175 x 125	200 x 150	300 x 200
75 x 50mm	MOG4/SO18	MOG5/SO18	MOG6/SO18
MILL	6.70	6.70	6.70
PPC	7.20	7.20	7.20
75 x 75mm	MOG4/SO19	MOG5/SO19	MOG6/SO19
MILL	6.70	6.70	6.70
PPC	7.20	7.20	7.20
100 x 75mm	MOG4/SO20	MOG5/SO20	MOG6/SO20
MILL	6.70	6.70	6.70
PPC	7.20	7.20	7.20
100 x 100mm	MOG4/SO21	MOG5/SO21	MOG6/SO21
MILL	8.00	8.00	8.00
PPC	8.50	8.50	8.50

Please Note

Sleeve Outlets can be used in place of Running Outlets giving increased flexibility and cost efficiency.

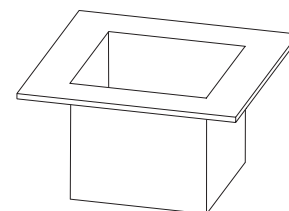

PRICE LIST

MOULDED OGEE GUTTER SYSTEM - LARGE SIZES

RUNNING OUTLETS - ROUND

Gutter (mm)	175 x 125	200 x 150	300 x 200
63mm Ø	MOG4/13	MOG5/13	MOG6/13
MILL	45.34	53.56	67.95
PPC	46.24	54.61	69.44
75mm Ø	MOG4/14	MOG5/14	MOG6/14
MILL	45.85	54.07	68.46
PPC	46.75	55.12	69.95
100mm Ø	MOG4/15	MOG5/15	MOG6/15
MILL	49.79	53.68	68.07
PPC	50.69	54.73	69.56
125mm Ø	MOG4/16	MOG5/16	MOG6/16
MILL	52.14	60.58	67.61
PPC	53.22	61.83	69.39
150mm Ø	MOG4/17	MOG5/17	MOG6/17
MILL	54.10	63.12	71.66
PPC	55.18	64.37	73.44

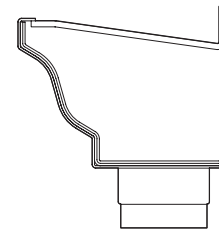
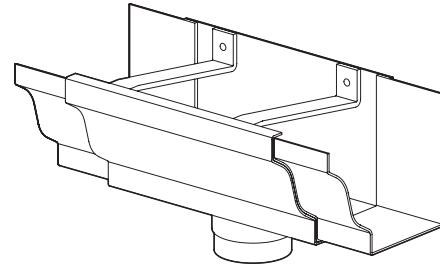

Please Note

Sleeve Outlets can be used in place of Running Outlets giving increased flexibility and cost efficiency.

RUNNING OUTLETS - SQUARE & RECTANGULAR

Gutter (mm)	175 x 125	200 x 150	300 x 200
75 x 50mm	MOG4/18	MOG5/18	MOG6/18
MILL	48.15	56.37	70.76
PPC	49.05	57.42	72.25
75 x 75mm	MOG4/19	MOG5/19	MOG6/19
MILL	48.74	56.96	71.35
PPC	49.64	58.01	72.84
100 x 75mm	MOG4/20	MOG5/20	MOG6/20
MILL	49.68	57.90	72.29
PPC	50.58	58.95	73.78
100 x 100mm	MOG4/21	MOG5/21	MOG6/21
MILL	53.45	58.55	72.94
PPC	54.35	59.60	74.43
150 x 100mm	MOG4/22	MOG5/22	MOG6/22
MILL	54.37	57.20	69.06
PPC	55.45	58.45	70.84
150 x 150mm	MOG4/23	MOG5/23	MOG6/23
MILL	59.32	65.17	70.13
PPC	60.40	66.42	71.91

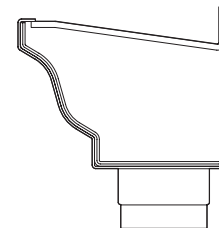
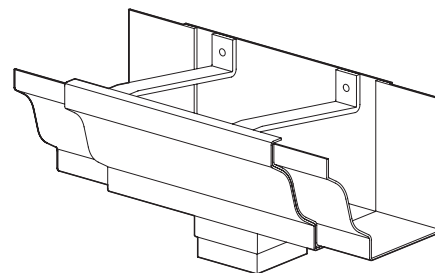

Please Note

Sleeve Outlets can be used in place of Running Outlets giving increased flexibility and cost efficiency.

PRICE LIST

FIXINGS & SEALANTS

Code	Qty	Description	Price
GM1	25	Gutter Fixing 38 x 5.5 A2 Stainless Steel	4.42
GM2	100	Gutter Fixing 38 x 5.5 A2 Stainless Steel	12.00
GM3	200	Gutter Fixing 38 x 5.5 A2 Stainless Steel	22.40



GM1 - GM5

Code	Qty	Description	Price
GM201	25	4.8 x 14.7 All Aluminium sealed Rivet	3.13
GM202	100	4.8 x 14.7 All Aluminium sealed Rivet	12.03
GM203	200	4.8 x 14.7 All Aluminium sealed Rivet	23.94



GM201 - GM203

Code	Qty	Description	Price
GM610	25	6.3mm STRUCTURAL Aluminium Rivet	10.66
GM620	100	6.3mm STRUCTURAL Aluminium Rivet	37.44



GM610 - GM620

Code	Qty	Description	Price
GM20	25	Downpipe Fixing 6 x 50 A2 Stainless Steel	9.05
GM21	100	Downpipe Fixing 6 x 50 A2 Stainless Steel	31.17



GM20 - GM21

Code	Qty	Description	Price
GM30	1	380ml Cartridge Silicone Sealant - Grey	11.07
GM32	1	1no 12mtr Reel Butyl Tape 12mm x 3mm	4.67
GM34	1	1 Litre Sealant Cleaner	10.96
GM40	1	0.5ltr Touch Up Paint - Colour to match order	23.35
GM50	1	1no Drill Bit 4.8mm	2.10
GM51	1	1no Drill Bit 6.4mm	3.32



GM30



GM32



GM50 - GM60

Code	Qty	Description	Price
GM910	1	Standard Rainwater Rivet Gun	19.52
GM920	1	Professional Rivet Gun - Interchangeable collets for rainwater and structural rivets	111.10



GM910



GM920

PRICE LIST

CARRIAGE CHARGES

GUTTERS, DOWNPIPES & HOPPERS

TOTAL NET ORDER VALUE (EXCLUDING VAT)		PRICE
£0 - £99	BOXED UP TO 10KG	£15.00 Min Charge
£0 - £99	3M LENGTHS UP TO 10KGS	£30.00
£100 - £624		£40.00
£625 - £1249		£55.00
£1250 PLUS		FREE DELIVERY

Delivery Exclusions Apply: Please see the Charges section below

COPING, FASCIAS & SOFFITS

TOTAL NET ORDER VALUE (EXCLUDING VAT)	PRICE
£0 - £150	£40.00
£151 - £1249	£95.00
£1250 PLUS	FREE DELIVERY

Delivery Exclusions Apply: Please see the Charges section below

CHARGES

With a fleet of Guttercrest vehicles and outside couriers, we deliver all our aluminium products to your local builders merchant or direct to site.

SCOTTISH MAINLAND

Standard carriage charges apply on Postcode areas: DG, EH, G, KA, KY, TD

ALSO TO INCLUDE: DD1 - DD7, FK1 - FK7, FK9 - FK15, FK8 STERLING ONLY (Rest of FK8 will be price on application), KY1 - KY16, PA1 - PA19, PH1 - PH4, PH12 - PH14

All other Scottish Mainland, carriage price on application.

NON MAINLAND

For delivery to Northern Ireland, The Republic of Ireland and all offshore Islands, carriage Price on application.

EXPORT

Price on application.

Tel: +44 (0)1691 663300

Email: info@guttercrest.co.uk

VAT will be charged at the appropriate rate.

