

GUTTERCREST

ALUMINIUM

SMOOTHLINE ROUND DOWNPIPES

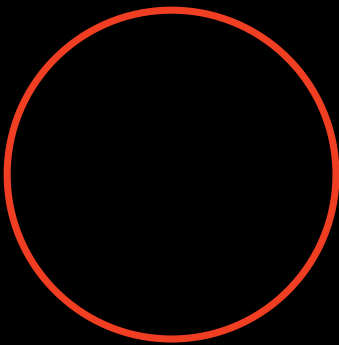

150mm
6"

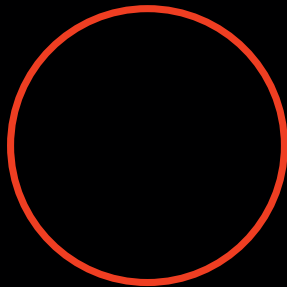

125mm
5"

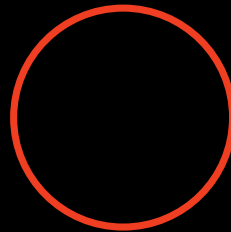

100mm
4"

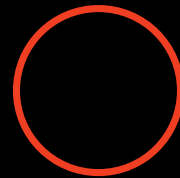

75mm
3"



63mm
2½"

PRICE LIST

PRICE LIST

SMOOTHLINE ROUND DOWNPIPE SYSTEM

DOWNPIPE LENGTHS

Pipe (mm)	63 Ø	75 Ø	100 Ø	125 Ø	150 Ø
3.0mtr	RW1S/1	RW2S/1	RW3S/1	RW4S/1	RW5S/1
MILL	27.18	32.79	43.08	84.00	102.13
PPC	32.31	38.98	51.38	94.17	114.57
1.5mtr	RW1S/4	RW2S/4	RW3S/4	RW4S/4	RW5S/4
MILL	16.07	19.10	24.99	48.67	58.33
PPC	18.64	22.19	29.14	53.76	64.56
1.0mtr	RW1S/5	RW2S/5	RW3S/5	RW4S/5	RW5S/5
MILL	10.72	12.73	16.53	32.71	39.16
PPC	12.43	14.79	19.30	36.11	43.31

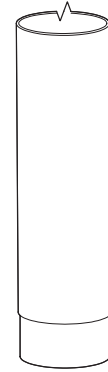

ACCESS PIPES & PLATES

Pipe (mm)	63 Ø	75 Ø	100 Ø	125 Ø	150 Ø
Pipe With Plate	RW1S/8	RW2S/8	RW3S/8	RW4S/8	RW5S/8
MILL	13.88	18.24	21.44	33.48	38.87
PPC	15.17	19.79	23.52	36.03	41.99
Plate Only	RW1/9	RW2/9	RW3/9	RW4/9	RW5/9
MILL	4.02	4.07	4.49	5.59	6.44
PPC	4.52	4.57	4.99	6.09	6.94

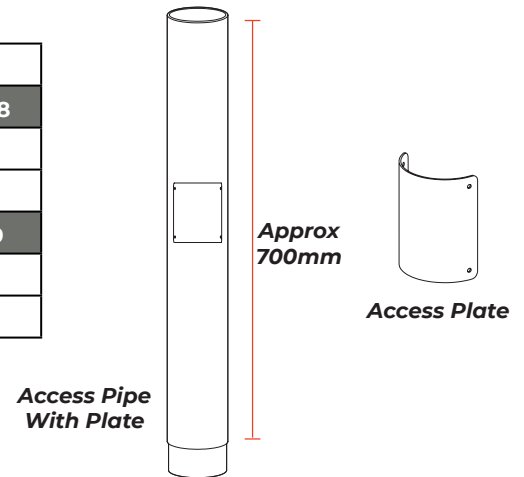

SHOES

Pipe (mm)	63 Ø	75 Ø	100 Ø	125 Ø	150 Ø
Shoe	RW1S/10	RW2S/10	RW3S/10	RW4S/10	RW5S/10
MILL	8.20	9.52	12.16	25.68	32.54
PPC	8.70	10.02	12.84	26.55	33.74

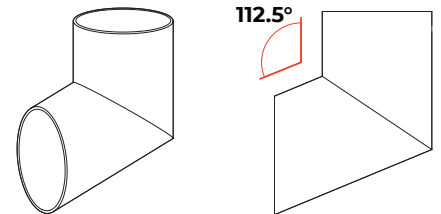

UNIVERSAL BRANCHES

Pipe (mm)	63 Ø	75 Ø	100 Ø	125 Ø	150 Ø
Branch	RW1S/11	RW2S/11	RW3S/11	RW4S/11	RW5S/11
MILL	16.73	19.04	26.87	40.50	51.18
PPC	17.37	19.81	28.05	42.33	56.29

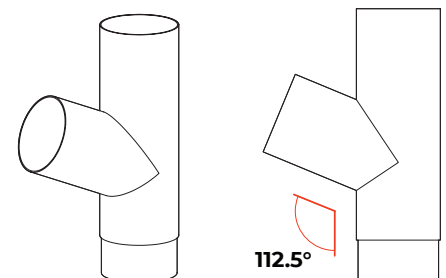

PRICE LIST

SMOOTHLINE ROUND DOWNPIPE SYSTEM

PIPE CLIPS

Pipe (mm)	63 Ø	75 Ø	100 Ø	125 Ø	150 Ø
Standard Pipe Clip	RW1/16	RW2/16	RW3/16	RW4/16	RW5/16
MILL	3.65	4.13	4.73	5.90	6.40
PPC	4.15	4.63	5.23	6.40	6.90

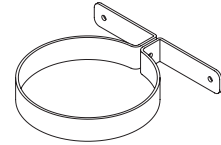

Standard Pipe Clip

Pipe (mm)	63 Ø	75 Ø	100 Ø	125 Ø	150 Ø
Tee Bkt 100mm	RW1/17	RW2/17	RW3/17	RW4/17	RW5/17
MILL	7.57	7.73	8.37	9.00	9.42
PPC	8.07	8.23	8.87	9.50	9.92
Tee Bkt 200mm	RW1/18	RW2/18	RW3/18	RW4/18	RW5/18
MILL	8.48	8.63	9.00	9.96	10.38
PPC	8.98	9.13	9.50	10.46	10.88
Tee Bkt 300mm	RW1/19	RW2/19	RW3/19	RW4/19	RW5/19
MILL	9.48	9.64	10.00	11.03	11.44
PPC	9.98	10.14	10.50	11.53	11.94

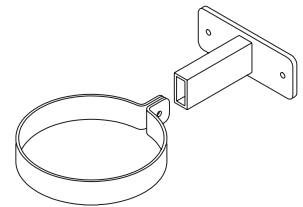

Tee bracket

Mullion Bkt 100mm	RW1/171	RW2/171	RW3/171	RW4/171	RW5/171
MILL	7.57	7.73	8.37	9.00	9.42
PPC	8.07	8.23	8.87	9.50	9.92
Mullion Bkt 200mm	RW1/181	RW2/181	RW3/181	RW4/181	RW5/181
MILL	8.48	8.63	9.00	9.96	10.38
PPC	8.98	9.13	9.50	10.46	10.88
Mullion Bkt 300mm	RW1/191	RW2/191	RW3/191	RW4/191	RW5/191
MILL	9.48	9.64	10.00	11.03	11.44
PPC	9.98	10.14	10.50	11.53	11.94

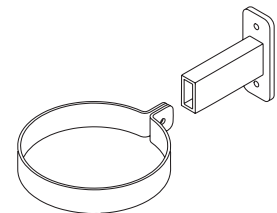

Mullion bracket

BENDS

Pipe (mm)	63 Ø	75 Ø	100 Ø	125 Ø	150 Ø
Bend	RW1S/21	RW2S/21	RW3S/21	RW4S/21	RW5S/21
MILL	8.06	8.62	12.14	21.74	27.21
PPC	8.56	9.12	12.86	22.68	28.43

NOTE: NORMALLY USED WITH A BRANCH

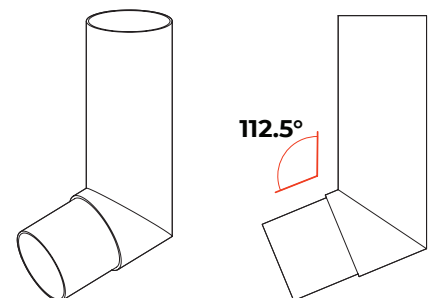

PRICE LIST

SMOOTHLINE ROUND DOWNPIPE SYSTEM

PLINTH OFFSETS

Pipe (mm)	63 Ø	75 Ø	100 Ø	125 Ø	150 Ø
Offset Up To 150mm	RW1S/23	RW2S/23	RW3S/23	RW4S/23	RW5S/23
MILL	23.17	25.84	30.67	55.71	66.76
PPC	24.14	27.02	32.28	57.71	69.25

NOTE: PLEASE STATE PROJECTION (P) SIZE

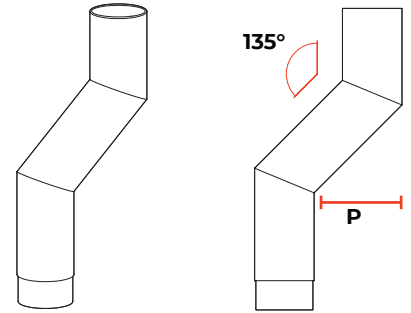

SWAN NECKS

SWAN NECK 1 PIECE

Pipe (mm)	63 Ø	75 Ø	100 Ø	125 Ø	150 Ø
One Piece 300mm	RW1S/25	RW2S/25	RW3S/25	RW4S/25	RW5S/25
MILL	32.73	35.47	40.39	66.89	79.17
PPC	33.75	36.71	42.10	69.05	81.88

NOTE: PLEASE STATE PROJECTION (P) SIZE

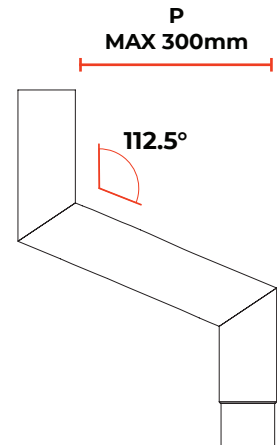

SWAN NECK 2 PIECE

Pipe (mm)	63 Ø	75 Ø	100 Ø	125 Ø	150 Ø
Two Piece 300mm	RW1S/26	RW2S/26	RW3S/26	RW4S/26	RW5S/26
MILL	18.95	21.27	27.90	54.60	68.64
PPC	20.07	22.63	29.81	56.99	71.68
Two Piece 450mm	RW1S/27	RW2S/27	RW3S/27	RW4S/27	RW5S/27
MILL	20.33	22.95	29.39	60.40	75.39
PPC	21.72	24.64	31.74	63.33	79.10
Two Piece 600mm	RW1S/28	RW2S/28	RW3S/28	RW4S/28	RW5S/28
MILL	21.75	24.67	31.65	64.85	80.85
PPC	23.42	26.70	34.45	68.34	85.24
Two Piece 900mm	RW1S/29	RW2S/29	RW3S/29	RW4S/29	RW5S/29
MILL	24.54	28.08	36.09	73.63	91.60
PPC	26.77	30.78	39.79	78.22	97.34
Two Piece 1200mm	RW1S/30	RW2S/30	RW3S/30	RW4S/30	RW5S/30
MILL	27.42	31.61	40.67	82.67	102.66
PPC	30.22	35.04	45.30	88.40	109.79

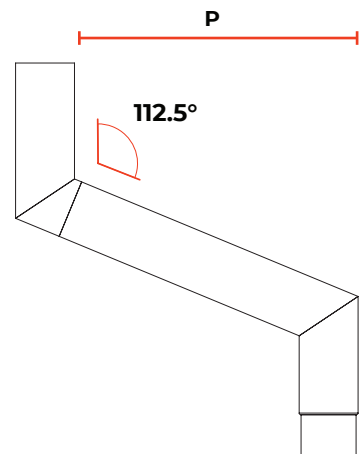

PRICE LIST

FIXINGS & SEALANTS

Code	Qty	Description	Price
GM1	25	Gutter Fixing 38 x 5.5 A2 Stainless Steel	4.42
GM2	100	Gutter Fixing 38 x 5.5 A2 Stainless Steel	12.00
GM3	200	Gutter Fixing 38 x 5.5 A2 Stainless Steel	22.40



GM1 - GM5

Code	Qty	Description	Price
GM201	25	4.8 x 14.7 All Aluminium sealed Rivet	3.13
GM202	100	4.8 x 14.7 All Aluminium sealed Rivet	12.03
GM203	200	4.8 x 14.7 All Aluminium sealed Rivet	23.94



GM201 - GM203

Code	Qty	Description	Price
GM610	25	6.3mm STRUCTURAL Aluminium Rivet	10.66
GM620	100	6.3mm STRUCTURAL Aluminium Rivet	37.44



GM610 - GM620

Code	Qty	Description	Price
GM20	25	Downpipe Fixing 6 x 50 A2 Stainless Steel	9.05
GM21	100	Downpipe Fixing 6 x 50 A2 Stainless Steel	31.17



GM20 - GM21

Code	Qty	Description	Price
GM30	1	380ml Cartridge Silicone Sealant - Grey	11.07
GM32	1	1no 12mtr Reel Butyl Tape 12mm x 3mm	4.67
GM34	1	1 Litre Sealant Cleaner	10.96
GM40	1	0.5ltr Touch Up Paint - Colour to match order	23.35
GM50	1	1no Drill Bit 4.8mm	2.10
GM51	1	1no Drill Bit 6.4mm	3.32



GM30



GM32



GM50 - GM60

Code	Qty	Description	Price
GM910	1	Standard Rainwater Rivet Gun	19.52
GM920	1	Professional Rivet Gun - Interchangeable collets for rainwater and structural rivets	111.10



GM910



GM920

PRICE LIST

CARRIAGE CHARGES

GUTTERS, DOWNPIPES & HOPPERS

TOTAL NET ORDER VALUE (EXCLUDING VAT)		PRICE
£0 - £99	BOXED UP TO 10KG	£15.00 Min Charge
£0 - £99	3M LENGTHS UP TO 10KGS	£30.00
£100 - £624		£40.00
£625 - £1249		£55.00
£1250 PLUS		FREE DELIVERY

Delivery Exclusions Apply: Please see the Charges section below

COPING, FASCIAS & SOFFITS

TOTAL NET ORDER VALUE (EXCLUDING VAT)	PRICE
£0 - £150	£40.00
£151 - £1249	£95.00
£1250 PLUS	FREE DELIVERY

Delivery Exclusions Apply: Please see the Charges section below

CHARGES

With a fleet of Guttercrest vehicles and outside couriers, we deliver all our aluminium products to your local builders merchant or direct to site.

SCOTTISH MAINLAND

Standard carriage charges apply on Postcode areas: DG, EH, G, KA, KY, TD

ALSO TO INCLUDE: DD1 - DD7, FK1 - FK7, FK9 - FK15, FK8 STERLING ONLY (Rest of FK8 will be price on application), KY1 - KY16, PA1 - PA19, PH1 - PH4, PH12 - PH14

All other Scottish Mainland, carriage price on application.

NON MAINLAND

For delivery to Northern Ireland, The Republic of Ireland and all offshore Islands, carriage Price on application.

EXPORT

Price on application.

Tel: +44 (0)1691 663300

Email: info@guttercrest.co.uk

VAT will be charged at the appropriate rate.

