

GUTTERCREST

ALUMINIUM

SQUARE & RECTANGLE DOWNPIPES



75 X 75 mm
3 X 3"



75 X 50 mm
3 X 2"



100 X 100 mm
4 X 4"



100 X 75 mm
4 X 3"



150 X 150 mm
6 X 6"

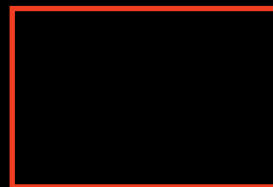

150 X 100 mm
6 X 4"

PRICE LIST

PRICE LIST

SQUARE & RECTANGULAR DOWNPIPE SYSTEM

DOWNPIPE LENGTHS

Pipe (mm)	75 x 50	75 x 75	100 x 75	100 x 100	150 x 100	150 x 150
3.0mtr	RW32/1	RW33/1	RW43/1	RW44/1	RW64/1	RW66/1
MILL	37.12	44.39	61.62	70.55	118.24	161.05
PPC	43.83	52.44	71.01	81.28	131.44	176.89
1.5mtr	RW32/4	RW33/4	RW43/4	RW44/4	RW64/4	RW66/4
MILL	23.17	27.42	37.04	41.91	70.19	93.49
PPC	26.52	31.44	41.73	47.27	76.79	101.41



ACCESS PIPES & PLATES

Pipe (mm)	75 x 50	75 x 75	100 x 75	100 x 100	150 x 100	150 x 150
Pipe With Plate	RW32/8	RW33/8	RW43/8	RW44/8	RW64/8	RW66/8
MILL	19.84	22.26	27.73	30.37	48.32	60.36
PPC	21.63	24.41	30.26	33.27	51.97	64.74
Plate Only	RW32/9	RW33/9	RW43/9	RW44/9	RW64/9	RW66/9
MILL	2.21	2.21	2.56	2.53	3.39	3.39
PPC	2.71	2.71	3.06	3.03	3.89	3.89

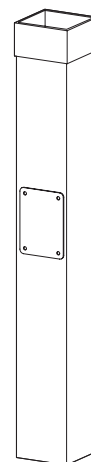

Approx
700mm

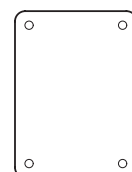

Access Plate

Access Pipe
With Plate

SHOES

Pipe (mm)	75 x 50	75 x 75	100 x 75	100 x 100	150 x 100	150 x 150
Shoe	RW32/10	RW33/10	RW43/10	RW44/10	RW64/10	RW66/10
MILL	14.62	16.61	19.19	18.31	34.01	46.94
PPC	15.12	17.15	19.83	19.11	35.08	48.48

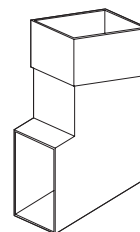

112.5°

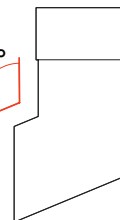

UNIVERSAL BRANCHES

Pipe (mm)	75 x 50	75 x 75	100 x 75	100 x 100	150 x 100	150 x 150	
Branch	112.5°	RW32/11	RW33/11	RW43/11	RW44/11	RW64/11	RW66/11
	92.5°	RW32/51	RW33/51	RW43/51	RW44/51	RW64/51	RW66/51
MILL		26.87	30.64	31.64	30.54	58.13	66.58
PPC		28.08	31.63	32.89	31.97	60.28	69.16

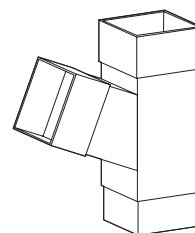

112.5°
or 92.5°

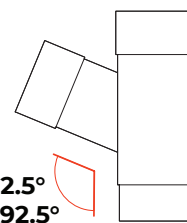

112.5° branch shown

PRICE LIST

SQUARE & RECTANGULAR DOWNPIPE SYSTEM

PIPE CLIPS & BRACKETS

Pipe (mm)	75 x 50	75 x 75	100 x 75	100 x 100	150 x 100	150 x 150
Standard Pipe Clip	RW32/16	RW33/16	RW43/16	RW44/16	RW64/16	RW66/16
MILL	2.55	2.55	2.65	2.65	4.60	4.92
PPC	3.05	3.05	3.15	3.15	5.10	5.42

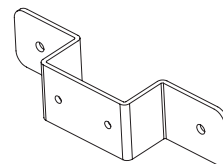

Standard Pipe Clip

Pipe (mm)	75 x 50	75 x 75	100 x 75	100 x 100	150 x 100	150 x 150
Tee Bkt 100mm	RW32/17	RW33/17	RW43/17	RW44/17	RW64/17	RW66/17
MILL	7.16	7.16	7.32	7.32	7.86	8.39
PPC	7.66	7.66	7.82	7.82	8.36	8.89
Tee Bkt 200mm	RW32/18	RW33/18	RW43/18	RW44/18	RW64/18	RW66/18
MILL	8.07	8.07	8.23	8.23	8.77	9.35
PPC	8.57	8.57	8.73	8.73	9.27	9.85
Tee Bkt 300mm	RW32/19	RW33/19	RW43/19	RW44/19	RW64/19	RW66/19
MILL	9.07	9.07	9.23	9.23	9.77	10.41
PPC	9.57	9.57	9.73	9.73	10.27	10.91

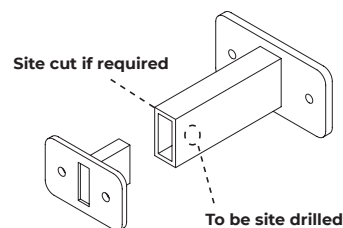

Tee Bracket

Pipe (mm)	75 x 50	75 x 75	100 x 75	100 x 100	150 x 100	150 x 150
Mullion Bkt 100mm	RW32/171	RW33/171	RW43/171	RW44/171	RW64/171	RW66/171
MILL	0.00	0.00	0.00	0.00	0.00	0.00
PPC	0.00	0.00	0.00	0.00	0.00	0.00
Mullion Bkt 200mm	RW32/181	RW33/181	RW43/181	RW44/181	RW64/181	RW66/181
MILL	0.00	0.00	0.00	0.00	0.00	0.00
PPC	0.00	0.00	0.00	0.00	0.00	0.00
Mullion Bkt 300mm	RW32/191	RW33/191	RW43/191	RW44/191	RW64/191	RW66/191
MILL	0.00	0.00	0.00	0.00	0.00	0.00
PPC	0.00	0.00	0.00	0.00	0.00	0.00

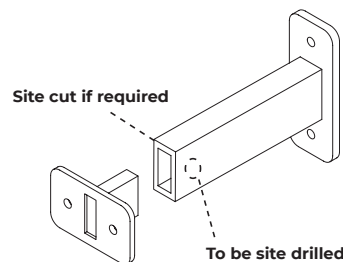

Mullion Bracket

Pipe (mm)	75 x 50	75 x 75	100 x 75	100 x 100	150 x 100	150 x 150
Flat Pipe Clip	RW32/14	RW33/14	RW43/14	RW44/14	RW64/14	RW66/14
MILL	2.62	2.62	2.71	2.71	3.31	3.31
PPC	3.12	3.12	3.21	3.21	3.81	3.81

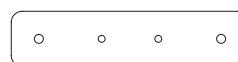

Flat Back Pipe Clip

Pipe (mm)	75 x 50	75 x 75	100 x 75	100 x 100	150 x 100	150 x 150
Concealed Pipe Clip	RW32/15	RW33/15	RW43/15	RW44/15	RW64/15	RW66/15
MILL	3.01	3.01	3.27	3.27	3.80	4.07
PPC	3.51	3.51	3.77	3.77	4.30	4.57

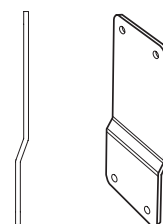

Concealed Pipe Clip

PRICE LIST

SQUARE & RECTANGULAR DOWNPIPE SYSTEM

CONNECTORS

Pipe (mm)	75 x 50	75 x 75	100 x 75	100 x 100	150 x 100	150 x 150
Connector	RW32/12	RW33/12	RW43/12	RW44/12	RW64/12	RW66/12
MILL	7.68	8.54	10.42	11.44	20.61	22.81
PPC	8.18	9.04	10.92	11.94	21.23	23.55

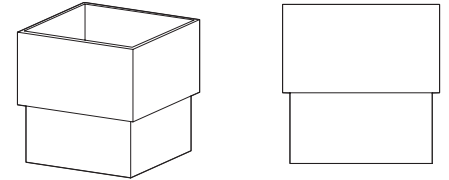

BENDS

Pipe (mm)	75 x 50	75 x 75	100 x 75	100 x 100	150 x 100	150 x 150	
Bend	112.5°	RW32/21	RW33/21	RW43/21	RW44/21	RW64/21	RW66/21
	92.5°	RW32/61	RW33/61	RW43/61	RW44/61	RW64/61	RW66/61
MILL	16.88	17.48	22.75	23.77	42.69	50.87	
PPC	17.38	17.98	23.37	24.50	43.64	52.12	

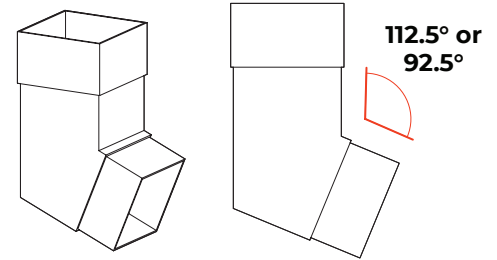

112.5° bend shown

NOTE: NORMALLY USED WITH A BRANCH

RECTANGULAR BENDS CAN ONLY BE USED AS A SIDE LEFT OR RIGHT NOT FORWARD OR REAR PROJECTING

PLINTH OFFSETS

Pipe (mm)	75 x 50	75 x 75	100 x 75	100 x 100	150 x 100	150 x 150
Offset Up To 150mm	RW32/23	RW33/23	RW43/23	RW44/23	RW64/23	RW66/23
MILL	31.75	35.17	40.61	45.00	65.73	77.42
PPC	32.80	36.24	42.04	46.93	67.05	79.58

NOTE: PLEASE STATE PROJECTION (P) SIZE

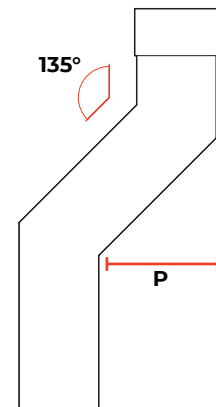

PRICE LIST

SQUARE & RECTANGULAR DOWNPIPE SYSTEM

SWAN NECKS

SWAN NECK 1 PIECE

Pipe (mm)		75 x 50	75 x 75	100 x 75	100 x 100	150 x 100	150 x 150
One Piece 300mm	112.5°	RW32/25	RW33/25	RW43/25	RW44/25	RW64/25	RW66/25
	92.5°	RW32/65	RW33/65	RW43/65	RW44/65	RW64/65	RW66/65
MILL		40.28	43.50	49.20	55.61	73.95	96.29
PPC		41.49	44.74	51.08	57.85	76.70	98.95

NOTE: PLEASE STATE PROJECTION (P) SIZE

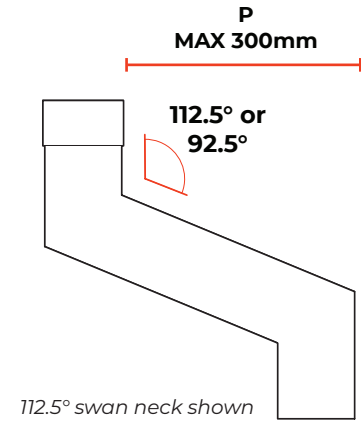

SWAN NECK 2 PIECE

Pipe (mm)		75 x 50	75 x 75	100 x 75	100 x 100	150 x 100	150 x 150
Two Piece 300mm	112.5°	RW32/26	RW33/26	RW43/26	RW44/26	RW64/26	RW66/26
	92.5°	RW32/66	RW33/66	RW43/66	RW44/66	RW64/66	RW66/66
MILL		31.01	36.11	47.72	49.21	79.67	92.64
PPC		32.38	37.74	49.63	51.42	82.38	96.08
Two Piece 450mm	112.5°	RW32/27	RW33/27	RW43/27	RW44/27	RW64/27	RW66/27
	92.5°	RW32/67	RW33/67	RW43/67	RW44/67	RW64/67	RW66/67
MILL		33.43	38.19	47.76	52.60	85.32	100.52
PPC		35.16	40.25	50.17	55.38	88.74	104.81
Two Piece 600mm	112.5°	RW32/28	RW33/28	RW43/28	RW44/28	RW64/28	RW66/28
	92.5°	RW32/68	RW33/68	RW43/68	RW44/68	RW64/68	RW66/68
MILL		34.52	40.33	50.60	56.10	90.96	107.83
PPC		36.63	42.84	53.18	59.47	94.81	111.81
Two Piece 900mm	112.5°	RW32/29	RW33/29	RW43/29	RW44/29	RW64/29	RW66/29
	92.5°	RW32/69	RW33/69	RW43/69	RW44/69	RW64/69	RW66/69
MILL		37.90	44.10	58.34	62.98	102.37	123.57
PPC		40.51	46.70	61.81	67.51	107.55	128.88
Two Piece 1200mm	112.5°	RW32/30	RW33/30	RW43/30	RW44/30	RW64/30	RW66/30
	92.5°	RW32/70	RW33/70	RW43/70	RW44/70	RW64/70	RW66/70
MILL		41.49	48.36	62.69	70.08	114.15	141.18
PPC		44.79	51.69	67.14	75.81	120.69	149.82

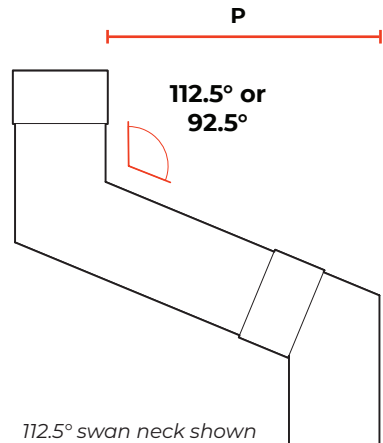

PRICE LIST

FIXINGS & SEALANTS

Code	Qty	Description	Price
GM1	25	Gutter Fixing 38 x 5.5 A2 Stainless Steel	4.42
GM2	100	Gutter Fixing 38 x 5.5 A2 Stainless Steel	12.00
GM3	200	Gutter Fixing 38 x 5.5 A2 Stainless Steel	22.40



GM1 - GM5

Code	Qty	Description	Price
GM201	25	4.8 x 14.7 All Aluminium sealed Rivet	3.13
GM202	100	4.8 x 14.7 All Aluminium sealed Rivet	12.03
GM203	200	4.8 x 14.7 All Aluminium sealed Rivet	23.94



GM201 - GM203

Code	Qty	Description	Price
GM610	25	6.3mm STRUCTURAL Aluminium Rivet	10.66
GM620	100	6.3mm STRUCTURAL Aluminium Rivet	37.44



GM610 - GM620

Code	Qty	Description	Price
GM20	25	Downpipe Fixing 6 x 50 A2 Stainless Steel	9.05
GM21	100	Downpipe Fixing 6 x 50 A2 Stainless Steel	31.17



GM20 - GM21

Code	Qty	Description	Price
GM30	1	380ml Cartridge Silicone Sealant - Grey	11.07
GM32	1	1no 12mtr Reel Butyl Tape 12mm x 3mm	4.67
GM34	1	1 Litre Sealant Cleaner	10.96
GM40	1	0.5ltr Touch Up Paint - Colour to match order	23.35
GM50	1	1no Drill Bit 4.8mm	2.10
GM51	1	1no Drill Bit 6.4mm	3.32



GM30



GM32



GM50 - GM60

Code	Qty	Description	Price
GM910	1	Standard Rainwater Rivet Gun	19.52
GM920	1	Professional Rivet Gun - Interchangeable collets for rainwater and structural rivets	111.10



GM910



GM920

PRICE LIST

CARRIAGE CHARGES

GUTTERS, DOWNPIPES & HOPPERS

TOTAL NET ORDER VALUE (EXCLUDING VAT)		PRICE
£0 - £99	BOXED UP TO 10KG	£15 Min Charge
£0 - £99	3M LENGTHS UP TO 10KGS	£30
£100 - £624		£40
£625 - £1249		£55
£1250 PLUS		FREE DELIVERY

Delivery Exclusions Apply:
Please see the Charges
section below

COPING, FASCIAS & SOFFITS

TOTAL NET ORDER VALUE (EXCLUDING VAT)	PRICE
£0 - £150	£40
£151 - £1249	£95
£1250 PLUS	FREE DELIVERY

Delivery Exclusions Apply:
Please see the Charges
section below

CHARGES

With a fleet of Guttercrest vehicles and outside couriers, we deliver all our aluminium products to your local builders merchant or direct to site.

SCOTTISH MAINLAND

Standard carriage charges apply on
Postcode areas: DG, EH, G, KA, KY, TD

ALSO TO INCLUDE: DD1 - DD7, FK1 - FK7, FK9 - FK15,
FK8 STERLING ONLY (Rest of FK8 will be price on application),
KY1 - KY16, PA1 - PA19, PH1 - PH4, PH12 - PH14

All other Scottish Mainland, carriage price on application.

NON MAINLAND

For delivery to Northern Ireland, The Republic of Ireland
and all offshore Islands, carriage Price on application.

EXPORT

Price on application.

Tel: +44 (0)1691 663300

Email: info@guttercrest.co.uk

VAT will be charged at the appropriate rate.

