

GUTTERCREST

ALUMINIUM

ROUND DOWNPIPES

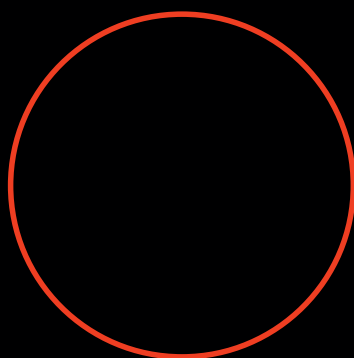

200mm
8"

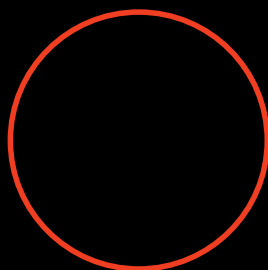

150mm
6"

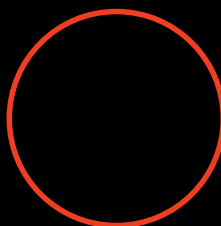

125mm
5"

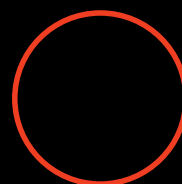

100mm
4"



75mm
3"



63mm
2½"

PRICE LIST

PRICE LIST

ROUND DOWNPIPE SYSTEM

DOWNPIPE LENGTHS

Pipe (mm)	63 Ø	75 Ø	100 Ø	125 Ø	150 Ø
3.0mtr	RW1/1	RW2/1	RW3/1	RW4/1	RW5/1
MILL	27.18	32.79	43.08	84.00	102.13
PPC	32.31	38.98	51.38	94.17	114.57
1.5mtr	RW1/4	RW2/4	RW3/4	RW4/4	RW5/4
MILL	16.07	19.10	24.99	48.67	58.33
PPC	18.64	22.19	29.14	53.76	64.56

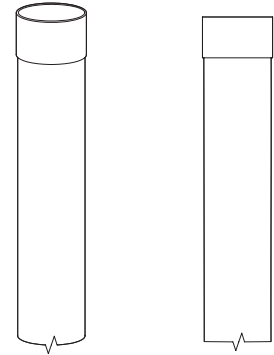

ACCESS PIPES & PLATES

Pipe (mm)	63 Ø	75 Ø	100 Ø	125 Ø	150 Ø
Pipe With Plate	RW1/8	RW2/8	RW3/8	RW4/8	RW5/8
MILL	13.88	18.24	21.44	33.48	38.87
PPC	15.17	19.79	23.52	36.03	41.99
Plate Only	RW1/9	RW2/9	RW3/9	RW4/9	RW5/9
MILL	4.02	4.07	4.49	5.59	6.44
PPC	4.52	4.57	4.99	6.09	6.94

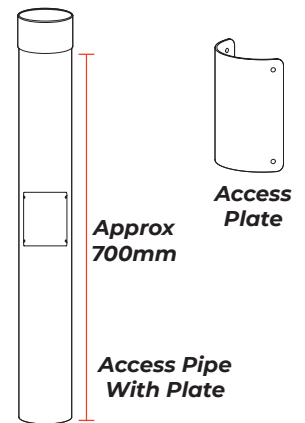

SHOES

Pipe (mm)	63 Ø	75 Ø	100 Ø	125 Ø	150 Ø
Shoe	RW1/10	RW2/10	RW3/10	RW4/10	RW5/10
MILL	8.89	10.21	13.20	27.15	34.02
PPC	9.39	10.71	13.88	28.02	35.22

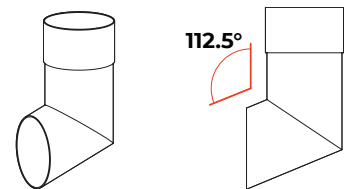

UNIVERSAL BRANCHES

Pipe (mm)	63 Ø	75 Ø	100 Ø	125 Ø	150 Ø
Branch	RW1/11	RW2/11	RW3/11	RW4/11	RW5/11
MILL	18.12	20.43	28.95	43.08	58.91
PPC	18.76	21.20	30.13	44.91	64.02

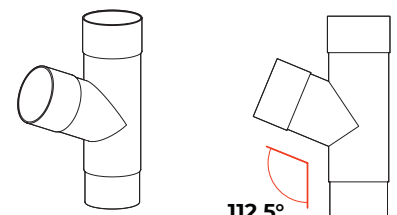

PRICE LIST

ROUND DOWNPIPE SYSTEM

CONNECTORS

Pipe (mm)	63 Ø	75 Ø	100 Ø	125 Ø	150 Ø
Connector	RW1/12	RW2/12	RW3/12	RW4/12	RW5/12
MILL	2.50	2.60	3.14	5.88	8.02
PPC	3.00	3.10	3.64	6.38	8.61

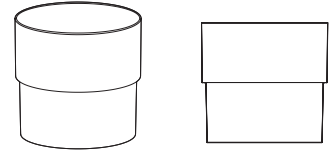

PIPE CLIPS

Pipe (mm)	63 Ø	75 Ø	100 Ø	125 Ø	150 Ø
Standard Pipe Clip	RW1/16	RW2/16	RW3/16	RW4/16	RW5/16
MILL	3.65	4.13	4.73	5.90	6.40
PPC	4.15	4.63	5.23	6.40	6.90

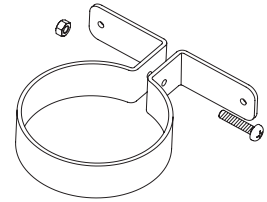

Standard Pipe Clip

Pipe (mm)	63 Ø	75 Ø	100 Ø	125 Ø	150 Ø
Tee Bkt 100mm	RW1/17	RW2/17	RW3/17	RW4/17	RW5/17
MILL	7.57	7.73	8.37	9.00	9.42
PPC	8.07	8.23	8.87	9.50	9.92
Tee Bkt 200mm	RW1/18	RW2/18	RW3/18	RW4/18	RW5/18
MILL	8.48	8.63	9.00	9.96	10.38
PPC	8.98	9.13	9.50	10.46	10.88
Tee Bkt 300mm	RW1/19	RW2/19	RW3/19	RW4/19	RW5/19
MILL	9.48	9.64	10.00	11.03	11.44
PPC	9.98	10.14	10.50	11.53	11.94

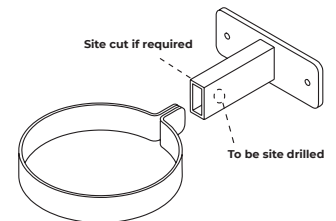

Tee bracket

Mullion Bkt 100mm	RW1/171	RW2/171	RW3/171	RW4/171	RW5/171
MILL	7.57	7.73	8.37	9.00	9.42
PPC	8.07	8.23	8.87	9.50	9.92
Mullion Bkt 200mm	RW1/181	RW2/181	RW3/181	RW4/181	RW5/181
MILL	8.48	8.63	9.00	9.96	10.38
PPC	8.98	9.13	9.50	10.46	10.88
Mullion Bkt 300mm	RW1/191	RW2/191	RW3/191	RW4/191	RW5/191
MILL	9.48	9.64	10.00	11.03	11.44
PPC	9.98	10.14	10.50	11.53	11.94

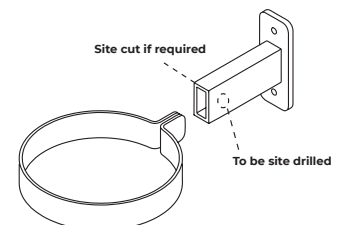

Mullion bracket

PRICE LIST

ROUND DOWNPIPE SYSTEM

BENDS

Pipe (mm)	63 Ø	75 Ø	100 Ø	125 Ø	150 Ø
Bend	RW1/21	RW2/21	RW3/21	RW4/21	RW5/21
MILL	8.75	9.31	12.14	23.21	27.21
PPC	9.25	9.81	12.86	24.15	28.43

NOTE: NORMALLY USED WITH A BRANCH

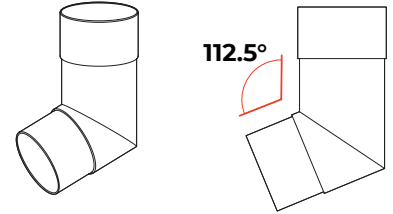

PLINTH OFFSETS

Pipe (mm)	63 Ø	75 Ø	100 Ø	125 Ø	150 Ø
Offset Up To 150mm	RW1/23	RW2/23	RW3/23	RW4/23	RW5/23
MILL	23.17	25.84	30.67	55.71	66.76
PPC	24.14	27.02	32.28	57.71	69.25

NOTE: PLEASE STATE PROJECTION (P) SIZE

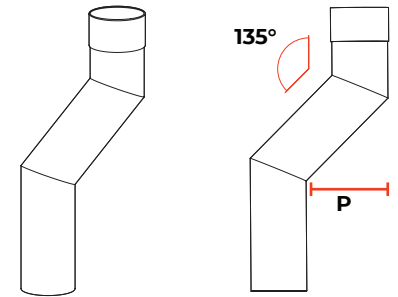

SWAN NECKS

SWAN NECK 1 PIECE

Pipe (mm)	63 Ø	75 Ø	100 Ø	125 Ø	150 Ø
One Piece 300mm	RW1/25	RW2/25	RW3/25	RW4/25	RW5/25
MILL	32.73	35.47	40.39	66.89	79.17
PPC	33.75	36.71	42.10	69.05	81.88

NOTE: PLEASE STATE PROJECTION (P) SIZE

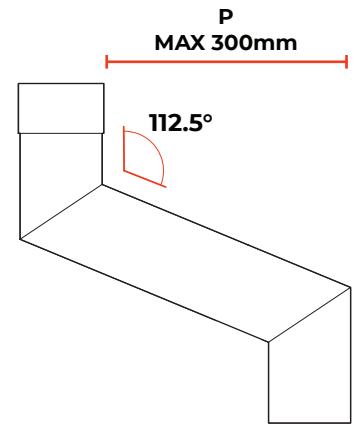

SWAN NECK 2 PIECE

Pipe (mm)	63 Ø	75 Ø	100 Ø	125 Ø	150 Ø
Two Piece 300mm	RW1/26	RW2/26	RW3/26	RW4/26	RW5/26
MILL	18.95	21.27	27.90	54.60	68.64
PPC	20.07	22.63	29.81	56.99	71.68
Two Piece 450mm	RW1/27	RW2/27	RW3/27	RW4/27	RW5/27
MILL	20.33	22.95	29.39	60.40	75.39
PPC	21.72	24.64	31.74	63.33	79.10
Two Piece 600mm	RW1/28	RW2/28	RW3/28	RW4/28	RW5/28
MILL	21.75	24.67	31.65	64.85	80.85
PPC	23.42	26.70	34.45	68.34	85.24
Two Piece 900mm	RW1/29	RW2/29	RW3/29	RW4/29	RW5/29
MILL	24.54	28.08	36.09	73.63	91.60
PPC	26.77	30.78	39.79	78.22	97.34
Two Piece 1200mm	RW1/30	RW2/30	RW3/30	RW4/30	RW5/30
MILL	27.42	31.61	40.67	82.67	102.66
PPC	30.22	35.04	45.30	88.40	109.79

